

リープヘル製  
オールテレーンクレーン  
吊上荷重550ton

## Technical Data

メインブーム50m  
Y型-ガイ付仕様

### 注意

- 1 定格総荷重はフックブロック、玉掛ワイヤー等の自重を含みます。また、下記の条件が考慮されていませんのでクレーンの操作には充分気をつけてください。
  - ① 地盤の強度、地震による影響
  - ② 作業速度に応じた動荷重および台風または強風による影響等
- 2 本機は水平に設置して、クレーン作業を行ってください。
- 3 作業半径は、クレーンの旋回中心から荷重の重心までの水平距離です。
- 4 メインブームの定格総荷重は補助ジブを取り除いた状態での値です。
- 5 メインブーム50m仕様で274トンを超える定格総荷重の場合は、特殊吊装置が必要です。

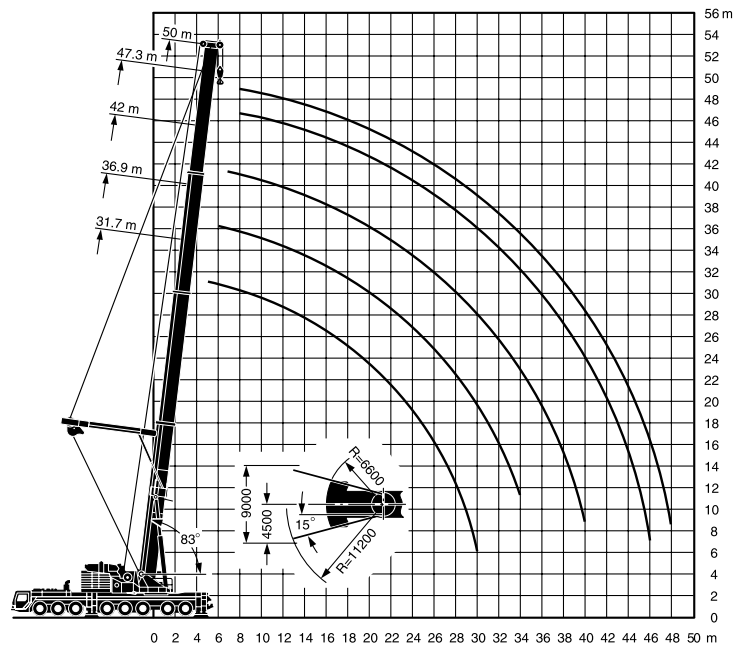

# メインブーム定格総荷重表

# LTM 1550N



16.1m-50m



10m×9.6m



360°



135t

メインブーム 長さ 作業半径(m)	16.1m		21.3m	26.5m	31.7m	36.9m	42.1m	47.3m	50m	
	1)	2)								
3	550	550	274							
3.5	440	440	274	274						
4	358	358	274	274	272					
4.5	301	301	274	274	262					
5	295	288	274	274	254	206				
6	261	256	245	244	233	188	166			
7	235	230	219	219	214	174	154	133		
8	213	208	197	197	196	162	144	124	108	
9	194	184	178	178	177	152	134	117	102	
10	177	165	161	161	161	143	124	110	97	
12	146	137	135	137	134	123	108	97	88	
14	124	116	116	117	115	109	96	86	79	
16				101	99	98	86	78	71	
18				88	87	87	78	70	64	
20				73	78	77	70	62	58	
22					70	69	65	58	53	
24					63	61	60	54	48.5	
26						55	55	51	45	
28						50	50	47.5	42	
30						46	46	44.5	39	
32							42	41	36	
34							39	38	34	
36								35.5	32.5	
38								33.5	30.5	
40								31.5	29	
42									27.4	
44									25.9	
46									19.8	
48									18.7	
ブーム 伸長率 (%)	I	0		46	46	46	92	92	92	100
	II	0		0	46	46	46	92	92	100
	III	0		0	0	46	46	46	92	100

1) 後方吊り、16tカウンターウエイト

2) 後方吊り、135tカウンターウエイト

TAB 216388,216390,216391



16.1m-50m

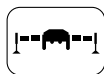

10m×9.6m



360°



105t

メインブーム 長さ 作業半径(m)	16.1m	21.3m	26.5m	31.7m	36.9m	42.1m	47.3m	50m	
	3	274							
3.5	274	274							
4	274	274	247						
4.5	263	261	238						
5	245	244	231	187					
6	217	215	212	171	151				
7	192	192	192	158	140	121			
8	171	171	170	147	131	113	98		
9	154	153	153	138	121	106	93	81	
10	139	139	138	130	113	100	88	76	
12	115	116	114	111	98	88	80	69	
14	97	98	96	97	87	79	72	62	
16		84	84	83	78	71	64	56	
18		73	73	72	70	63	58	52	
20		64	64	63	62	57	53	47	
22			56	55	55	53	48.5	42.5	
24			50	50	49.5	48.5	44	38.5	
26				46	44	43.5	41	35.5	
28				41.5	40	40.5	38	33	
30				38	36	37	35.5	30.5	
32					32.5	33.5	32.5	27.9	
34					30	30.5	29.5	26.3	
36						28.1	27	24.7	
38						25.9	24.8	23.3	
40						24	22.8	21.9	
42							21	20.6	
44							19.4	19.4	
46							18	17.9	
48								16.7	
ブーム 伸長率 (%)	I	0	46	46	46	92	92	92	100
	II	0	0	46	46	92	92	92	100
	III	0	0	0	46	0	46	92	100

TAB 216362

# メインブーム定格総荷重表 (Y-ガイ仕様)

T3Y3

LTM 1550N

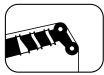

31.7m-50m

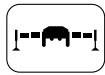

10m x 9.6m

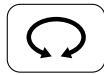

360°

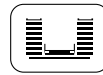

165t



メインブーム 作業半径(m) 長さ	31.7m		36.9m			42.1m	47.3m	50m	
	8			182					
9	178	158	168	169		158	148	132	
10	164	154	155	156	146	147	139	132	
12	141	142	135	135	135	128	123	119	
14	122	123	118	118	120	116	110	107	
16	106	106	104	105	107	103	100	97	
18	93	93	91	92	95	92	91	89	
20	82	83	81	81	84	82	82	82	
22	73	74	71	72	75	73	74	74	
24	65	66	64	65	67	65	66	67	
26	59	59	57	58	61	59	60	60	
28	51	52	52	52	55	53	54	55	
30	41.5	42	46.5	47.5	50	48	49.5	50	
32			42.5	43	46	44	45	45.5	
34			35.5	37	39.5	40	41.5	41.5	
36						36.5	38	38	
38						33.5	35	35	
40						27	32.5	32.5	
42							29.8	30	
44							26.5	27.8	
46							16.5	25.8	
48								19.5	
ブーム 伸長率 (%)	I	46	0	92	92	0	92	92	100
	II	46	92	92	46	92	92	92	100
	III	46	46	0	46	92	46	92	100

TAB 216262

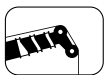

31.7m-50m

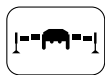

10m x 9.6m



360°



135t



メインブーム 作業半径(m) 長さ	31.7m		36.9m			42.1m	47.3m	50m	
	5	209	176						
6	202	170	212	194	164				
7	197	166	198	188	158	183			
8	192	162	182	180	154	170	156	132	
9	178	158	168	169	149	158	148	132	
10	163	154	155	156	146	147	139	132	
12	136	136	134	135	135	128	123	119	
14	115	116	114	115	117	114	110	107	
16	99	100	98	99	101	99	98	97	
18	86	87	85	85	88	86	87	86	
20	76	76	74	75	78	76	77	77	
22	67	67	65	66	69	67	68	68	
24	59	60	58	59	62	59	61	61	
26	53	54	52	52	55	53	54	55	
28	47.5	48.5	46.5	47	50	47.5	49	49.5	
30	41.5	42	41.5	42.5	45.5	43	44.5	44.5	
32			37.5	38	41	39	40.5	40.5	
34			34	34.5	37.5	35.5	36.5	37	
36						32	33.5	33.5	
38						29.4	30.5	31	
40						26.9	28.1	28.3	
42							25.9	26.1	
44							23.8	24	
46							16.5	22.1	
48								19.5	
ブーム 伸長率 (%)	I	46	0	92	92	0	92	92	100
	II	46	92	92	46	92	92	92	100
	III	46	46	0	46	92	46	92	100

TAB 216263

# 起伏式ジブ定格総荷重表

TN LTM 1550N

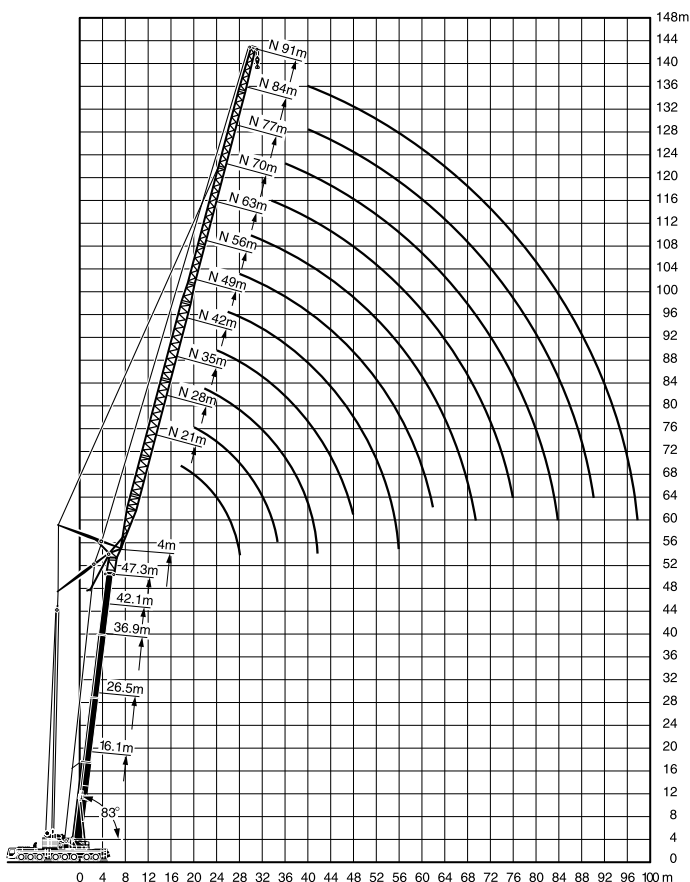

### 注意

- 1 定格総荷重はフックブロック、玉掛ワイヤー等の自重を含みます。  
また、下記の条件が考慮されていませんのでクレーンの操作には充分気をつけてください。  
① 地盤の強度、地震による影響  
② 作業速度に応じた動荷重および台風または強風による影響等
- 2 本機は水平に設置して、クレーン作業を行ってください。
- 3 作業半径は、クレーンの旋回中心から荷重の重心までの水平距離です。
- 4 メインブームの定格総荷重は補助ジブを取り除いた状態での値です。
- 5 メインブーム50m仕様で274トンを超える定格総荷重の場合は、特殊吊装置が必要です。

83°  
 16.1m-47.3m  
 21m-91m  
 10m x 9.6m  
 360°  
 165t

メインブーム長さ ジブ長さ 作業半径(m)	16.1m+4m*										26.5m+4m*															
	21m	28m	35m	42m	49m	56m	63m	70m	77m	84m	91m	21m	28m	35m	42m	49m	56m	63m	70m	77m	84m	91m				
14	121	112										108														
16	114	103	92									98	91													
18	103	96	88	75								92	85	76												
20	93	90	83	72	62							87	80	73	63											
22	84	84	79	70	60	49						82	75	69	61	53										
24	64	77	75	67	58	47.5	41					75	71	66	59	51	42.5									
26		70	70	65	56	46	39	30.5					68	63	57	50	41.5	35.5								
28		65	65	63	54	44	39	29.2	26.9				63	60	55	49	40.5	35	27.9							
30		52	60	59	53	42.5	38	28	26				59	58	53	47.5	40	34.5	26.9	24.2						
32			56	55	52	41	37.5	27	25.1	19.4			54	54	51	46	39	34	26	23.7	18.7					
34			50	52	51	40	36.5	25.9	24.3	18.7	16.3			50	50	44.5	38.5	33	25.2	23.2	18.1	15.7				
36				40.5	48.5	48	38.5	35.5	25	23.5	18	15.7			47.5	47	43	37.5	32.5	24.4	22.6	17.5	15.2			
38				31.5	45.5	45	37.5	35	24.1	22.8	17.3	15.2			44	42	36.5	32	23.6	22	16.9	14.7				
40					39.5	42.5	36.5	34	23.3	22.1	16.7	14.7				41.5	41	35.5	31.5	22.9	21.5	16.4	14.3			
42					33.5	40	35.5	33.5	22.6	21.5	16.1	14.2				39	38.5	34.5	31	22.2	20.9	15.8	13.8			
44						27.6	37.5	35	33	21.8	20.9	15.6	13.8			35	36.5	34	30.5	21.5	20.4	15.4	13.4			
46							33	34	32.5	21.1	20.3	15.1	13.4				28.1	34.5	33	29.8	20.9	19.9	14.3			
48							28.1	33	31.5	20.5	19.8	14.7	13.1				33	32.5	29.4	20.3	19.4	14.5	12.8			
50							23.5	31	31	20	19.2	14.3	12.7				31	30.5	29.1	19.8	19	14.1	12.4			
52							19.2	27.4	30.5	19.6	18.7	13.9	12.4				26	29.2	28.8	19.4	18.5	13.7	12.1			
54								23.7	28.4	19.2	18.4	13.5	12.1					27.9	27.6	19.1	18.1	13.3	11.8			
56								20.2	25.9	18.8	18.1	13.1	11.8					24.6	26.3	18.7	17.8	12.9	11.5			
58									16.9	23.4	18.4	17.7	11.5					20.8	25.1	18.4	17.5	12.7	11.3			
60										20.6	18	17.4	12.5	11.2					24	18	17.2	12.4	11.1			
62										17.5	17.6	17.1	12.2	11					17.1	22.6	17.7	17	12.2	10.9		
64										14.5	17.3	16.8	12	10.8					19.3	17.4	16.7	12	10.7			
66											11.6	17	16.5	11.8	10.6					16.2	17.1	16.5	11.8	10.5		
68												14.8	16.3	11.5	10.4						16.8	16.3	11.6	10.4		
70												12.4	16	11.3	10.3							16.3	16	11.4	10.2	
72												10.1	15.3	11.1	10.1								13.5	15.8	11.2	10.1
74													13.4	10.9	9.9								10.5	15.6	10.9	9.9
76													11.1	10.6	9.8									14.7	10.8	9.7
78													9	10.4	9.6									12.9	10.6	9.6
80													6.8	10.2	9.4									10.4	10.4	9.4
82														9.9	9.3										10.2	9.3
84														7.9	9.1										10	9.1
86														6.1	9										9.3	9
88															8										7.1	8.9
90															6.4											8.7
92															5											7.5
94															3.5											5.8
ブーム 伸長率 (%)	I							0																	46	
	II							0																	46	
	III							0																	0	

\*アダプター





# 起伏式ジブ定格総荷重表

TN LTM 1550N



メインブーム長さ		47.3m+4m*										
ジブ長さ		21m	28m	35m	42m	49m	56m	63m	70m	77m	84m	91m
作業半径(m)	ジブ長さ	21m	28m	35m	42m	49m	56m	63m	70m	77m	84m	91m
28	34.5											
30	32											
32	30.5											
34	29.1											
36												
38												
40												
42												
44												
46												
48												
50												
52												
54												
56												
58												
60												
62												
64												
66												
68												
70												
72												
74												
76												
78												
80												
82												
84												
86												
88												
90												
92												
94												
96												
98												
100												
104												
ブーム伸長率(%)	I											
	II											
	III											

\*アダプター

TAB 216157.5

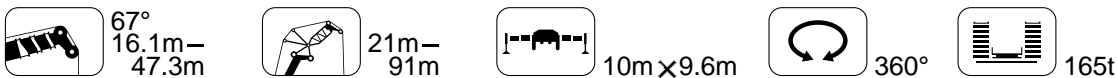

メインブーム長さ		16.1m+4m*										26.5m+4m*											
ジブ長さ		21m	28m	35m	42m	49m	56m	63m	70m	77m	84m	91m	21m	28m	35m	42m	49m	56m	63m	70m	77m	84m	91m
作業半径(m)	ジブ長さ	21m	28m	35m	42m	49m	56m	63m	70m	77m	84m	91m	21m	28m	35m	42m	49m	56m	63m	70m	77m	84m	91m
22	79																						
24	72																						
26	66																						
28	61																						
30																							
32																							
34																							
36																							
38																							
40																							
42																							
44																							
46																							
48																							
50																							
52																							
54																							
56																							
58																							
60																							
62																							
64																							
66																							
68																							
70																							
72																							
74																							
76																							
78																							
80																							
82																							
84																							
86																							
88																							
90																							
92																							
94																							
96																							
98																							
100																							
ブーム伸長率(%)	I																						
	II																						
	III																						

\*アダプター

TAB 216163.1/2

# 起伏式ジブ定格総荷重表

TN LTM 1550N



メインブーム長さ		36.9m+4m*										42.1m+4m*											
ジブ長さ		21m	28m	35m	42m	49m	56m	63m	70m	77m	84m	91m	21m	28m	35m	42m	49m	56m	63m	70m	77m	84m	91m
32	37.5																						
34	35																						
36	33.5												30										
38		32											28.5										
40		30.5											26.9	25.7									
42		28.8	28.3										24.3	23.1	22.3								
44		27.5	26.8										21.9	21.2	20.2								
46		26.4	25.4	24.7									21	20.2	19.2								
48			24.1	23.5										19.2	18.3								
50			23.2	22.3	21.5									18.1	17.4	16.3							
52			22.3	21.2	20.5									17.5	16.5	15.5							
54				20.3	19.4	18.3								15.7	14.7	13.5							
56				19.6	18.5	17.4								15.7	14.7	13.5							
58				18.9	17.5	16.6	15.6							14.9	14	12.7							
60				18.4	16.9	15.7	14.8							14.4	13.2	12.1	10.9						
62					16.3	15	14.1	13.3						14.2	12.6	11.4	10.3						
64					15.7	14.2	13.3	12.6							11.9	10.8	9.7	8.6					
66					15.2	13.7	12.6	11.9	11.5						11.5	10.2	9.1	8					
68						13.2	12	11.3	10.9						11.3	9.7	8.6	7.5	6.8				
70						12.7	11.4	10.7	10.4	9.9					9.1	8	7.1	6.3					
72						12.3	10.9	10.1	9.8	9.3					8.8	7.5	6.6	6	5.2				
74						12	10.5	9.5	9.2	8.8	7.9				8.6	7	6.2	5.6	4.9				
76							10.1	9.1	8.7	8.3	7.4				8.5	6.5	5.8	5.3	4.6	3.7			
78							9.7	8.7	8.2	7.8	7					6.2	5.4	4.9	4.3	3.4			
80							9.4	8.4	7.7	7.3	6.6					6.1	5	4.6	4	3.1			
82								8	7.3	6.8	6.2					6	4.6	4.3	3.8	2.9			
84								7.7	7	6.4	5.8						4.4	4	3.5	2.7			
86								7.3	6.7	6	5.4						4.3	3.7	3.3	2.4			
88									6.4	5.7	5						4.2	3.4	3	2.2			
90									6.1	5.5	4.6						4.2	3.3	2.8	2			
92									5.8	5.3	4.3							3.2	2.5	1.8			
94									5.6	5.1	4.1							3.1	2.3	1.5			
96										4.8	3.9							3.1	2.2	1.3			
98										4.6	3.7								2.1	1.1			
100										4.4	3.6								2.1				
104										4.4	3.4								2				
ブーム 伸長率 (%)	I						92										92						
	II						92										92						
	III						0										46						

\*アダプター

TAB 216163.3/4

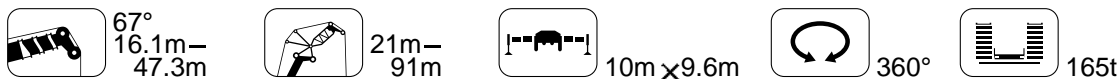

メインブーム長さ		47.3m+4m*									
ジブ長さ		21m	28m	35m	42m	49m	56m	63m	70m	77m	84m
36	24.7										
38	23.3										
40	22										
42		20.8									
44		19.7									
46		18.6	17.9								
48		17.6	17								
50		16.8	16	15.1							
52			15.1	14.3							
54			14.4	13.5	12.6						
56			13.8	12.7	11.8						
58				12	11.1	9.9					
60				11.5	10.5	9.2					
62				11.1	9.9	8.6					
64				10.7	9.4	8	7.4				
66					9	7.5	6.7				
68					8.6	6.9	6.1	5.2			
70					8.3	6.5	5.8	4.8			
72						6.2	5.4	4.4	4.1		
74						6	5	4.1	3.7		
76						6	4.7	3.8	3.4		
78						5.7	4.4	3.6	3.1	3	
80						5.5	4.2	3.3	2.9	2.4	
82							4.1	3	2.6	2.1	
84							3.9	2.8	2.4	1.9	
86							3.8	2.7	2.2	1.7	
88								2.5	1.9	1.5	
90								2.4	1.7	1.3	
92								2.3	1.6	1.1	
94								2.1	1.5		
96									1.4		
ブーム 伸長率 (%)	I						92				
	II						92				
	III						92				

\*アダプター

TAB 216163.5



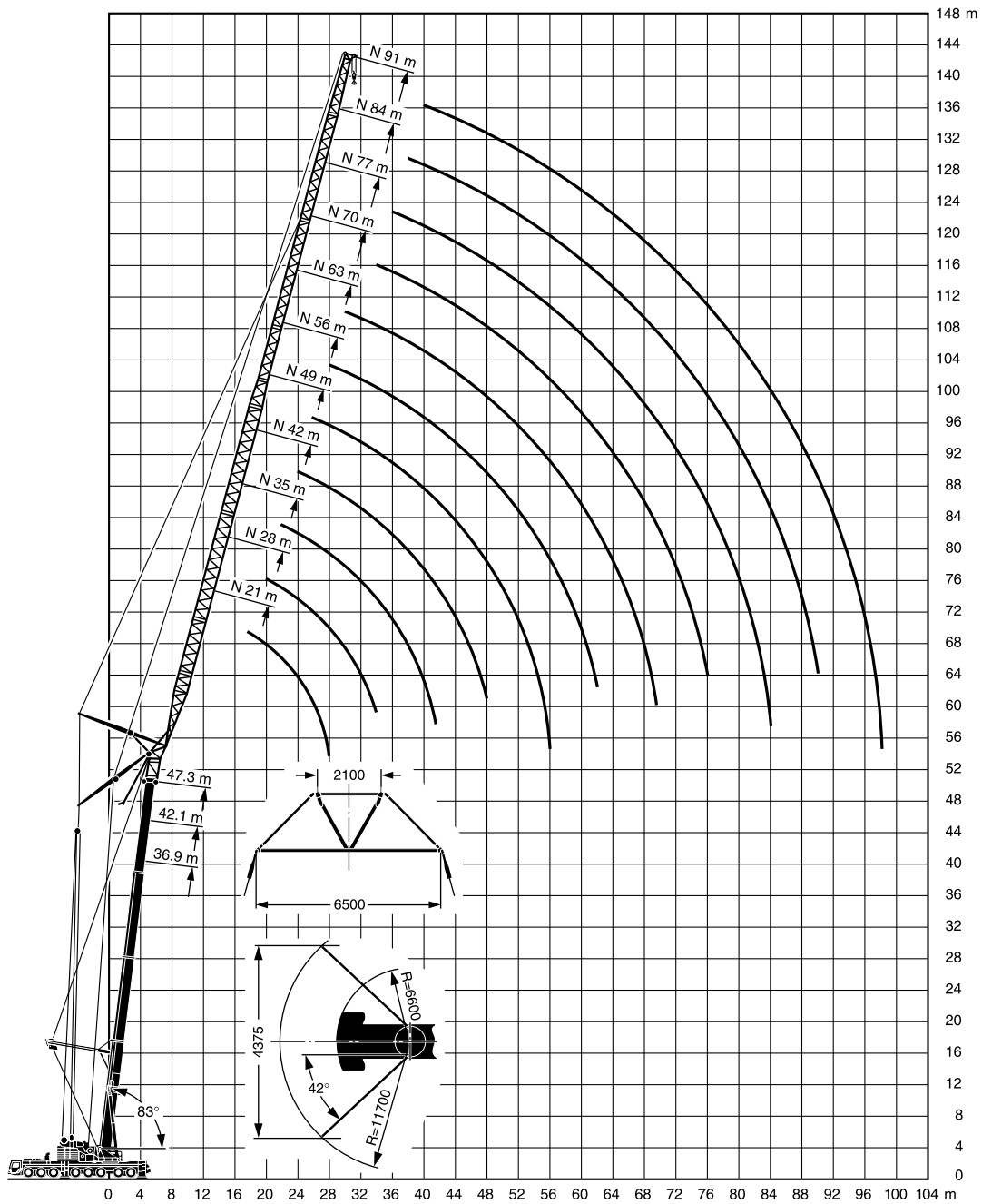

**注意**

- 1 定格総荷重はフックブロック、玉掛ワイヤー等の自重を含みます。  
また、下記の条件が考慮されていませんのでクレーンの操作には充分気をつけてください。  
① 地盤の強度、地震による影響  
② 作業速度に応じた動荷重および台風または強風による影響等
- 2 本機は水平に設置して、クレーン作業を行ってください。
- 3 作業半径は、クレーンの旋回中心から荷重の重心までの水平距離です。
- 4 メインブームの定格総荷重は補助ジブを取り除いた状態での値です。
- 5 メインブーム50m仕様で274トンを超える定格総荷重の場合は、特殊吊装置が必要です。





# 起伏式ジブ定格総荷重表 (Y-ガイ仕様)

TAY3N

LTM 1550N

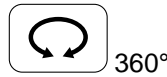
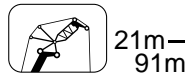

メインブーム長さ ジブ長さ 作業半径(m)	36.9m+4m*											42.1m+4m*					
	21m	28m	35m	42m	49m	56m	63m	70m	77m	84m	91m	21m	28m	35m	42m	49m	56m
32	44.5																
34	41.5																
36	39											40					
38		38										37.5					
40		35.5										35					
42		33.5	33									34					
44		32	29.2									32					
46		30	27.7	28.6								30.5	29.5				
48			27.1	27.1								28.7	27.9				
50			26.3	25.7	24.8							27.2	26.4	25.8			
52			25	24.4	23.5								25	24.4	23.1	22.5	
54				23.2	22.3	21.7							23.8	22	21.3	20.2	19.7
56				22.1	21.2	20.6							22	20.9	19.9	19.3	18.7
58				21	20.2	19.6	19.1							19	18.3	17.8	17.8
60				20.1	19.2	18.6	18.2							18.2	17.5	16.9	16.1
62					18.3	17.8	17.3	16.9							16.7	16.1	15.4
64					17.5	17.3	17.3	16.9	16.1						16.3	15.7	15.4
66					16.8	16.2	15.7	15.4	14.6						15.3	14.7	14.7
68						15.5	15.7	14.6	13.9								14.1
70						14.8	14.4	14	13.2	12.6							13.4
72						14.2	13.7	13.3	12.6	12							12.9
74						13.6	13.1	12.7	12	11.4	10.8						12.3
76							12.6	12.2	11.5	10.9	10.2						
78							12	11.6	10.9	10.3	9.7						
80							11.5	11.1	10.4	9.8	9.2						
82								10.6	9.9	9.3	8.7						
84								10.2	9.5	8.9	8.3						
86								9.8	9	8.5	7.9						
88								9.3	8.6	8.1	7.5						
90									8.3	7.7	7.1						
92									7.9	7.3	6.7						
94									7.5	7	6.4						
96										6.6	6						
98										6.3	5.7						
100										6	5.4						
104										5.7	5.2						
108										4.8	4.8						
ブーム 伸長率 (%)	92											92					
	0											46					

\*アダプター

TAB 216288

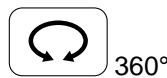

メインブーム長さ ジブ長さ 作業半径(m)	42.1m+4m*						47.3m+4m*									
	63m	70m	77m	84m	91m	21m	28m	35m	42m	49m	56m	63m	70m	77m	84m	91m
36						36										
38						34										
40						32	31									
42							29.2									
44							27.6	26.7								
46							26.1	25.3								
48							24.8	24	23.3							
50								22.7	22.1							
52								21	20.1							
54								20	19.1							
56								19	18.1	17.6						
58	17.1							18.1	17.3	16.7						
60	16.2							17.3	16.4	15.9						
62	15.4	15.1						16.5	15.7	15.1						
64	14.7	14.3							15	14.4	14.4	14.4				
66	14	13.7	12.9						14.3	13.7	13	12.6				
68	13.4	13	12.3						13.7	13.1	12.4	12				
70	12.8	12.4	11.7						13.7	12.5	11.8	11.4	10.7			
72	12.2	11.8	11.1	10.5					12	11.3	10.9	10.1	10.1			
74	11.7	11.3	10.6	9.9					11.4	10.8	10.4	9.6	9			
76	11.2	10.8	10	9.4	9.1				10.9	10.3	9.9	9.1	8.5			
78	10.7	10.3	9.6	8.9	8.6					9.8	9.4	8.7	8.1	7.7		
80	10.2	9.8	9.1	8.5	8.2					9	8.6	8.2	7.6	7.3		
82		9.4	8.7	8.1	7.7					9	8.6	8.2	7.8	7.2	6.9	
84		9	8.3	7.6	7.3						8.2	7.8	7.4	6.8	6.5	
86		8.6	7.9	7.3	6.9						7.8	7.4	7.1	6.5	6.1	
88		8.2	7.5	6.9	6.6						7.4	7.1	6.7	6.1	5.8	
90			7.1	6.5	6.2						7.1	6.7	6.4	5.8	5.5	
92			6.8	6.2	5.9							6.7	6.4	5.8	5.5	
94			6.5	5.9	5.6							6.4	6.1	5.5	5.2	
96				5.6	5.3							6.1	5.8	5.2	4.9	
98				5.4	5.1							5.8	5.5	4.9	4.7	
100				5.1	4.9							5.5	5.2	4.6	4.5	
104				4.9	4.4							5.2	4.8	4.3	4.3	
108				4.4	4							4.9	4.5	4.1	3.9	3.5
ブーム 伸長率 (%)	92						92									
	46						92									

\*アダプター

TAB 216288



# 起伏式ジブ定格総荷重表 (Y-ガイ仕様、スペーサー付) TAY3SN

# LTM 1550N

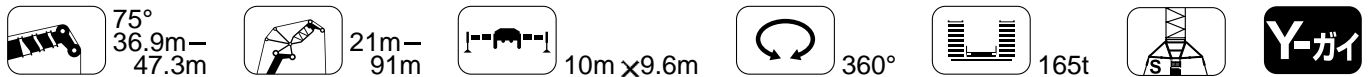

メインブーム長さ ジブ長さ 作業半径(m)	36.9m+4m*										42.1m+4m*						
	21m	28m	35m	42m	49m	56m	63m	70m	77m	84m	91m	21m	28m	35m	42m	49m	56m
24	66																
26	61	60										59					
28	56	56										55	54				
30	52	52	51									51	50				
32	49	48	47									47.5	46.5	46			
34		45	44	43.5									43.5	43			
36		42	41	40.5	40								41	40	39.5		
38		39.5	38.5	38	37.5								38.5	37.5	37	36.5	
40			36.5	36	35	34.5							36.5	35.5	35	34	
42			34.5	34	33	32.5	32							33	32.5	31.5	31.5
44			32.5	32	31.5	31	30.5							31.5	31	30.5	29.7
46			31	30.5	29.7	29.1	28.7	24.3						30	29.5	28.9	28.1
48				28.8	28.1	27.6	27.2	23.6							28	27.3	26.6
50				26.7	26.2	25.8	25.8	22.9	21.6						26.6	26	25.2
52				25.4	24.9	24.5	24.5	22.2	20.5	15.7					25.3	24.7	23.9
54				24.2	23.7	23.3	23.3	21.6	20.5	18.3					24.1	23.5	22.7
56				23.1	22.6	22.2	22.2	21	20	14.8	13					22.4	21.6
58				21.5	21.1	20.5	20.5	19.5	19.5	14.4	12.6					21.4	20.6
60				21.1	20.5	20.2	20.2	19.5	19.1	14	12.3					20.4	19.7
62					19.6	19.3	18.6	18.2	18.2	13.6	12						18.8
64					18.8	18.4	17.8	17.3	17.3	13.2	11.7						18
66					18	17.6	17	16.5	16.5	12.9	11.4						17.2
68						16.9	16.2	15.8	15.8	12.6	11.1						16.5
70						16.2	15.5	15.1	15.1	12.3	10.9						
72						15.5	14.9	14.4	14.4	12.1	10.7						
74						14.9	14.3	13.8	13.8	11.8	10.5						
76						13.7	13.2	12.7	12.7	11.6	10.3						
78						13.1	12.7	12.2	12.2	11.3	10.1						
80							12.6	12.1	12.1	11	9.9						
82								11.6	11.6	10.8	9.7						
84								11.1	11.1	10.5	9.6						
86								10.7	10.7	10.1	9.4						
88								10.2	10.2	9.7	9.1						
90										9.3	8.7						
92										8.9	8.3						
94										8.5	7.9						
96											7.6						
98											7.3						
100											6.9						
ブーム 伸長率 (%)	I					92											
	II					92											
	III					0									92		

\*アダプター

TAB 221512

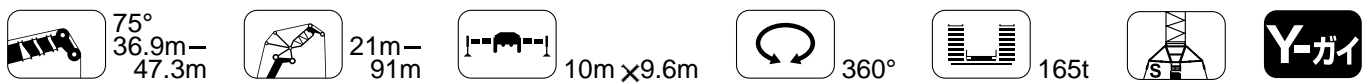

メインブーム長さ ジブ長さ 作業半径(m)	42.1m+4m*					47.3m+4m*										
	63m	70m	77m	84m	91m	21m	28m	35m	42m	49m	56m	63m	70m	77m	84m	91m
28						52										
30						49.5	48.5									
32						46	45.5									
34						43	42.5	41.5								
36							40	39	38							
38							37.5	36.5	36							
40							35.5	34.5	33.5	33						
42							33.5	32.5	32	31						
44	29.2						31	30	29.4	28.8						
46	27.6						29.2	28.4	27.8	27.2						
48	26.1	23.6					27.7	26.9	26.3	25.8	26.5					
50	24.8	23						25.6	24.9	24.4	23.7					
52	23.5	22.3	20.9					24.3	23.7	23.2	22.5	22.9				
54	22.3	21.7	20.4	15.3				23.2	22.5	22	21.3	22.1				
56	21.2	20.6	19.9	14.9				22.1	21.5	21	20.3	19.9				
58	20.2	19.6	19.1	14.5	12.6				20.5	20	19.3	19	20			
60	19.3	18.7	18.2	14.1	12.3				19.6	19.1	18.4	18.1	18.2	14.4		
62	18.4	17.8	17.3	13.7	12				18.7	18.2	17.6	17.2	17.3	14	12.2	
64	17.6	17	16.5	13.3	11.7					18.2	16.8	16.4	16.5	13.7	11.9	
66	16.8	16.2	15.7	12.9	11.4					17.4	16	15.6	15.7	13.3	11.6	
68	16.1	15.5	15	12.7	11.2					16.6	15.3	14.9	14.9	13	11.4	
70	15.4	14.8	14.3	12.4	10.9					15.9	14.7	14.3	14.2	12.6	11.1	
72	14.8	14.2	13.7	12.1	10.7					15.3	14.3	13.6	13.6	12.4	10.9	
74	14.2	13.5	13.1	11.9	10.5						14	13.7	13.7	12.1	10.7	
76		13	12.5	11.6	10.3						13.4	13.1	12.9	11.8	10.5	
78		12.4	12	11.4	10.1						12.9	12.5	12.5	11.2	10.1	
80		11.9	11.5	10.9	10							12	11.3	10.7	9.7	
82		11.5	11	10.4	9.8							11.5	10.8	10.2	9.2	
84			10.5	9.9	9.3							11	10.3	9.7	8.8	
86			10.1	9.5	8.9							10.6	9.9	9.3	8.4	
88			9.6	9.1	8.5								9.4	8.8	8.1	
90				8.7	8.1									8.4	7.7	
92				8.3	7.7									8.1	7.3	
94				7.9	7.4									7.7	7	
96				7.6	7									7.3	6.6	
98					6.7									7	6.3	
100					6.4									6.7	6.2	
104															6	
ブーム 伸長率 (%)	I				92											
	II				92											
	III				46									92		

\*アダプター

TAB 221512

# 起伏式ジブ定格総荷重表 (Y-ガイ仕様、スペーサー付) TAY3SN

# LTM 1550N

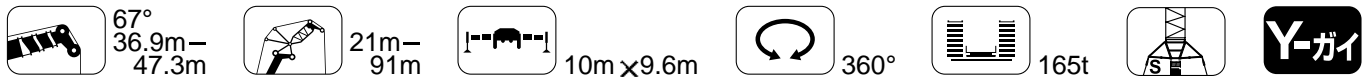

メインブーム長さ ジブ長さ 作業半径(m)	36.9m+4m*											42.1m+4m*					
	21m	28m	35m	42m	49m	56m	63m	70m	77m	84m	91m	21m	28m	35m	42m	49m	56m
32	44																
34	41																
36	38.5	37.5										39.5					
38		35.5										37					
40		33.5	32.5									35	34				
42		31.5	30.5									30	29.3				
44		29.8	28.9	28.2								28.5	27.7				
46			27.3	26.7								27	26.2	25.6			
48			25.9	25.3	24.6								24.8	24.2			
50			24.6	24	23.3								23.6	23	22.3		
52				22.8	22.1	21.5							22.4	21.8	21.1		
54				21.7	21	20.4								20.8	20.1	19.3	
56				20.7	20	19.4	19							19.8	19.1	18.3	
58					19.1	18.5	18							18.9	18.2	17.4	
60					18.2	17.6	17.2	16.5						18	17.3	16.5	
62					17.4	16.8	16.4	15.7							16.5	15.8	
64					16.6	16.1	15.6	15	14.5						15.8	15	
66						15.3	14.9	14.3	13.8						15.1	14.4	
68						14.7	14.2	13.6	13.1	12.5						13.7	
70						14.1	13.6	13	12.5	11.9						13.1	
72						13.5	13	12.4	11.9	11.3	10.7					12.5	
74							12.5	11.8	11.3	10.7	10.1						
76							11.9	11.3	10.8	10.2	9.6						
78							11.4	10.8	10.3	9.7	9.1						
80								10.3	9.8	9.2	8.6						
82								9.9	9.4	8.8	8.2						
84								9.5	9	8.4	7.8						
86								9.1	8.5	8	7.4						
88									8.2	7.6	7						
90									7.8	7.2	6.6						
92									7.4	6.9	6.3						
94										6.6	6						
96										6.2	5.6						
98										5.8	5.2						
100										5.4	4.8						
102										5	4.4						
104										4.7	4.1						
106																	
108																	
ブーム 伸長さ (S)	92											92					
	0											46					

\*アダプター

TAB 221514



メインブーム長さ ジブ長さ 作業半径(m)	42.1m+4m*						47.3m+4m*									
	63m	70m	77m	84m	91m	21m	28m	35m	42m	49m	56m	63m	70m	77m	84m	91m
36						35.5										
38						33.5										
40						31.5	30.5									
42							28.9									
44							27.3									
46							25.9	26.5								
48							24.5	25.1								
50								23.8	22.9							
52								22.5	21.7							
54								21.4	20.6	19.9						
56								20.4	19.6	18.9						
58	16.9								18.7	18	17.4					
60	16.1								17.8	17.1	16.5					
62	15.3								17	16.3	15.7					
64	14.6	14.6							16.2	15.5	15					
66	13.9	13.2	12.8							14.8	14.2	14.2				
68	13.3	12.6	12.1							14.2	13.6	12.9	12.5			
70	12.7	12	11.5							13.5	13	12.3	11.9			
72	12.1	11.4	11	10.3							12.4	11.7	11.3	10.6		
74	11.6	10.9	10.4	9.8							11.8	11.1	10.8	10		
76	11	10.4	9.9	9.3	8.7						11.3	10.6	10.3	9.5	8.9	
78	10.6	9.9	9.4	8.8	8.2						10.8	10.2	9.8	9	8.4	
80	10.1	9.5	9	8.4	7.8							9.7	9.3	8.6	7.9	7.6
82		9.1	8.6	8	7.3							9.3	8.9	8.1	7.5	7.2
84		8.7	8.1	7.6	6.9							8.9	8.5	7.7	7.1	6.8
86		8.3	7.8	7.2	6.6								8.1	7.3	6.7	6.4
88		7.9	7.4	6.8	6.2								7.7	7	6.3	6
90			7	6.4	5.8								7.3	6.6	6	5.7
92			6.7	6.1	5.5								7	6.3	5.6	5.4
94			6.4	5.8	5.3									5.9	5.4	5.2
96				5.5	5									5.6	5.2	4.9
98				5.3	4.8									5.4	4.9	4.7
100				5	4.6										4.7	4.5
102				4.8	4.2										4.5	4.2
104				4.6	4										4.4	4.1
106				4.4	3.8											3.8
108				4.2	3.8											3.4
ブーム 伸長さ (S)	92						92									
	46						92									

\*アダプター

TAB 221514

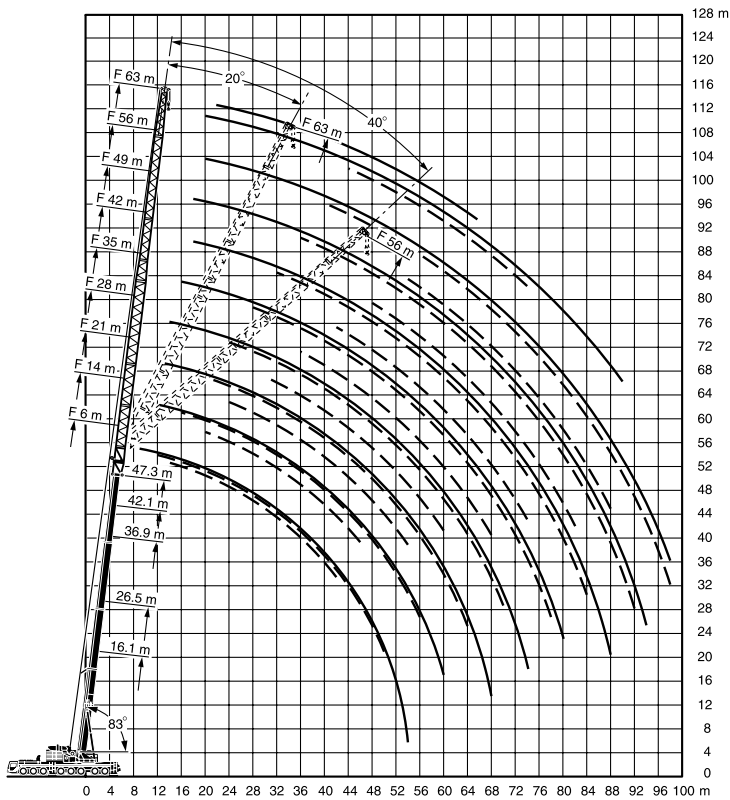

### 注意

- 1 定格総荷重はフックブロック、玉掛ワイヤー等の自重を含みます。  
また、下記の条件が考慮されていませんのでクレーンの操作には充分気をつけてください。  
① 地盤の強度、地震による影響  
② 作業速度に応じた動荷重および台風または強風による影響等
- 2 本機は水平に設置して、クレーン作業を行ってください。
- 3 作業半径は、クレーンの旋回中心から荷重の重心までの水平距離です。
- 4 メインブームの定格総荷重は補助ジブを取り除いた状態での値です。
- 5 メインブーム50m仕様で274トンを超える定格総荷重の場合は、特殊吊装置が必要です。



16.1m-50.1m



0°-63m

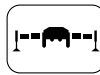

10m x 9.6m



360°



135t

メインブーム長さ ジブ長さ	16.1m+2.2m*									26.5m+2.2m*
作業半径(m)	6m	14m	21m	28m	35m	42m	49m	56m	63m	6m
4	143									143
4.5	143	99								143
5	143	94								138
6	143	85	76							132
7	143	77	71	56						126
8	125	71	66	52	43					115
9	118	65	61	49	40	34				101
10	109	61	57	46	38	32	26.8			88
12	86	53	49.5	40.5	34	28.6	24.1	20.3		75
14	66	47	44.5	36.5	30.5	25.9	21.9	18.5	15.6	63
16	55	42.5	39.5	32.5	27.6	23.6	20	16.9	14.3	55
18	46.5	39	35	29.3	25.2	21.6	18.4	15.5	13.2	50
20	39	35.5	31.5	26.5	22.8	19.9	16.9	14.3	12.1	44.5
22	33.5	32.5	28.4	24.1	20.7	18.3	15.6	13.2	11.2	40
24		30.5	25.7	22.1	18.9	16.7	14.5	12.2	10.4	36
26		28.4	23.3	20.2	17.5	15.3	13.4	11.3	9.6	32.5
28		26.1	21.1	18.5	16.2	14	12.2	10.5	8.9	
30		23.9	19.5	16.9	15	13.1	11.2	9.7	8.3	
32			18.1	15.3	13.8	12.2	10.3	8.9	7.7	
34			16.8	14.1	12.6	11.4	9.6	8.1	7.1	
36			15.6	13.2	11.6	10.6	9	7.5	6.4	
38			14.4	12.3	10.6	9.7	8.4	7	5.8	
40				11.5	9.8	8.9	7.8	6.6	5.4	
42				10.7	9.2	8.2	7.3	6.2	5.1	
44				10	8.7	7.5	6.7	5.7	4.8	
46					8.1	7.1	6.1	5.4	4.5	
48					7.6	6.6	5.6	4.9	4.2	
50					7.1	6.3	5.1	4.5	3.9	
52					6.6	5.9	4.8	4.1	3.6	
54						5.5	4.6	3.7	3.3	
56						5.2	4.3	3.5	3	
58						4.8	4	3.2	2.7	
60							3.8	3	2.5	
62							3.5	2.8	2.3	
64							3.3	2.6	2.1	
66							3.1	2.4	1.9	
68								2.2		
70								2.1		
72								1.9		
ブーム 伸長率 (%)	I				0					46
	II				0					46
	III				0					0

\*アダプター

TAB 216428



チルトタイプ固定式ジブ定格総荷重表

TNZF LTM 1550N

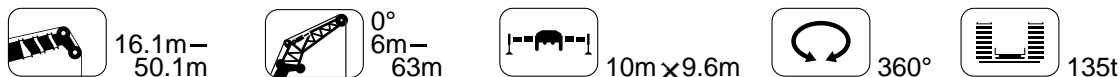

メインブーム長さ ジブ長さ 作業半径(m)	36.9m+2.2m*									42.1m+2.2m*
	6m	14m	21m	28m	35m	42m	49m	56m	63m	6m
8	117									
9	109	73								94
10	103	70	58							89
12	91	64	53	41	33					81
14	81	59	49.5	38	30.5	25.1	20.3			73
16	72	55	46	35.5	28.4	23.4	19	15.6		66
18	65	51	43.5	33	26.6	22	17.7	14.5	12.3	60
20	59	47.5	40.5	31	25	20.7	16.7	13.6	11.6	54
22	54	44.5	38	29.3	23.5	19.5	15.7	12.8	10.9	49.5
24	49	41.5	36	27.6	22.2	18.4	14.8	12.1	10.3	45.5
26	45	39.5	33.5	26.1	21	17.4	14	11.4	9.7	42
28	41	37.5	31	24.6	19.9	16.5	13.3	10.8	9.2	38.5
30	38.5	35.5	29	23.2	18.9	15.7	12.6	10.2	8.7	35.5
32	36	33	27.2	21.8	17.9	14.9	11.9	9.6	8.2	32.5
34	33.5	31	25.7	20.6	16.8	14.2	11.3	9.1	7.7	30.5
36	31	28.8	24.3	19.5	15.9	13.4	10.8	8.6	7.3	28.7
38	29.1	26.8	22.9	18.4	15.2	12.6	10.2	8.2	6.9	26.8
40	27	25.1	21.7	17.4	14.4	12	9.7	7.8	6.6	25.1
42	24.9	23.8	20.5	16.5	13.7	11.5	9.1	7.4	6.2	23.5
44		22.6	19.3	15.6	13	10.9	8.7	6.9	5.9	22.3
46		21.5	18.5	14.7	12.3	10.5	8.3	6.5	5.5	21.2
48		20.4	17.8	13.9	11.6	10	7.9	6.2	5.2	20
50		19.2	17.1	13.2	11	9.5	7.5	5.9	5	
52			16.4	12.6	10.4	8.9	7.2	5.6	4.7	
54			15.8	12.1	9.8	8.5	6.8	5.4	4.5	
56			15.2	11.7	9.3	8	6.5	5.1	4.3	
58			13.7	11.2	8.9	7.5	6.1	4.9	4.1	
60				10.8	8.6	7.1	5.7	4.6	3.8	
62				10.4	8.2	6.8	5.4	4.4	3.6	
64				10	7.9	6.5	5.1	4.1	3.4	
66					7.6	6.3	4.7	3.9	3.2	
68					7.3	6	4.5	3.6	3	
70					7	5.8	4.4	3.4	2.8	
72					6.7	5.5	4.2	3.2	2.6	
74						5.3	4.2	3.2	2.4	
76						5.1	3.9	2.9	2.2	
78						4.9	3.7	2.7	2	
80							3.6	2.6	1.9	
82							3.4	2.5	1.7	
84							3.3	2.3	1.6	
86								2.2	1.5	
88								2.1	1.3	
90								2		
ブーム 伸長率 (%)					92					92
					46					46
					46					46

\*アダプター

TAB 216428

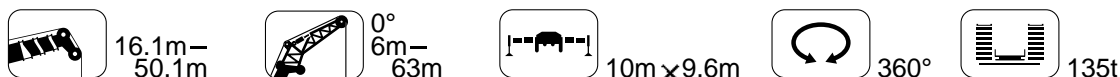

メインブーム長さ ジブ長さ 作業半径(m)	47.3m+2.2m*									50m+2.2m*	
	6m	14m	21m	28m	35m	42m	49m	56m	63m	6m	63m
9	80										
10	76										64
12	69	56	48								57
14	63	52	44	35							52
16	58	48	41	33	26						47.5
18	53	44.5	38	31.5	24.6	20.1	16.1				43
20	49	41.5	35.5	29.8	23.4	19.1	15.2	12.7	10.3		39.5
22	45.5	38.5	33.5	28.4	22.2	18.2	14.4	12	9.8		36.5
24	42	36	31	27.1	21.2	17.4	13.8	11.4	9.2	34	9
26	39	33.5	29.3	25.7	20.3	16.6	13.1	10.9	8.8	31.5	8.5
28	36	31.5	27.6	24.3	19.4	15.9	12.5	10.4	8.4	29.1	8.1
30	33.5	29.6	26	22.9	18.5	15.2	12	9.9	8	27	7.8
32	30.5	27.7	24.6	21.7	17.7	14.5	11.4	9.5	7.6	25	7.4
34	28.3	26	23.3	20.5	17	13.9	10.9	9	7.2	23.1	7.1
36	26.5	24.4	21.9	19.5	16.3	13.3	10.5	8.6	6.9	21.4	6.8
38	24.9	22.8	20.6	18.5	15.7	12.8	10	8.2	6.6	20.1	6.4
40	23.3	21.3	19.4	17.6	15	12.3	9.6	7.8	6.2	18.9	6.1
42	21.9	20	18.3	16.6	14.4	11.9	9.2	7.5	5.9	17.6	5.8
44	20.5	18.9	17.2	15.6	13.7	11.4	8.8	7.2	5.6	16.4	5.5
46	19.2	17.8	16.3	14.7	13.1	10.9	8.5	6.9	5.4	15.2	5.1
48	18.2	16.7	15.5	13.9	12.5	10.4	8.1	6.6	5.1	14.1	4.7
50	17.3	15.7	14.7	13.2	11.9	10	7.8	6.3	4.9	13.2	4.4
52	16.5	14.8	13.9	12.5	11.2	10	7.4	6.1	4.7	12.4	4.1
54	15.9	13.9	13.1	11.9	10.6	9.6	7.1	5.8	4.4	11.6	3.7
56	12.7	13.3	12.3	11.3	10	8.7	6.8	5.6	4.2	10.9	3.4
58		12.7	11.6	10.8	9.6	8.2	6.5	5.4	4.1		3.1
60		12.1	10.9	10.2	9.1	7.9	6.1	5.1	3.9		2.8
62			10.4	9.7	8.6	7.6	5.8	4.9	3.7		2.5
64			9.9	9.1	8.2	7.3	5.5	4.7	3.5		2.3
66			9.5	8.5	7.8	7	5.3	4.4	3.3		2
68			9	8.1	7.4	6.7	5.1	4.2	3.1		1.8
70				7.7	7	6.4	4.9	4	2.9		
72				7.3	6.6	6.1	4.7	3.8	2.7		
74				7	6.2	5.8	4.5	3.6	2.6		
76					5.9	5.5	4.3	3.5	2.4		
78					5.6	5.2	4.2	3.3	2.3		
80					5.4	4.9	4	3.1	2.1		
82						4.7	3.8	3	2		
84						4.5	3.7	2.8	1.8		
86						4.3	3.5	2.7	1.7		
88						4.1	3.3	2.5	1.6		
90							3.2	2.4	1.5		
92							2.9	2.2	1.4		
94							2.7	2.1			
96								1.9			
98								1.7			
ブーム 伸長率 (%)					92					100	
					92					100	
					92					100	

\*アダプター

TAB 216428

# チルトタイプ固定式ジブ定格総荷重表

TNZF

LTM 1550N

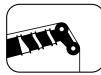

16.1m-  
50.1m

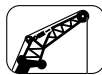

20°  
6m-  
63m

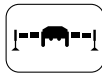

10m x 9.6m

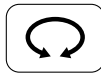

360°



135t

メインブーム長さ		16.1m+2.2m*									26.5m+2.2m*
ジブ長さ		6m	14m	21m	28m	35m	42m	49m	56m	63m	6m
作業半径(m)											
6	82										
7	74										83
8	67										77
9	61										72
10	57	43.5									67
12	49.5	40									60
14	43.5	37	33								54
16	39	34.5	30	24.9							49
18	35	32	27.9	23							45
20	32.5	30	26.1	21.4	17.9						41.5
22	30	28.7	24.2	19.9	16.6						38.5
24		27.4	22.3	18.7	15.5	13.5					36
26		26.4	20.6	17.5	14.5	12.6					34
28		25.1	19.2	16.3	13.6	11.8					32.5
30		23.8	18	15.1	12.8	11					31
32			16.9	14	12	10.3					29.7
34			16.1	13.2	11.2	9.7			7.2		
36			15.4	12.4	10.4	9.2		6.7			
38				11.7	9.8	8.7		7.4			5.3
40				11.1	9.2	8.2		7			4.9
42				10.6	8.7	7.8		6.6			4.6
44				10.2	8.1	7.3		6.3			4.3
46					7.7	6.8		5.9			4
48					7.4	6.4		5.5			3.8
50					7.1	6.4		5.2			3.5
52						6		4.9			3.3
54						5.7		4.6			3.1
56						5.4		4.3			2.9
58						5.2		4.1			2.7
60						5		3.9			2.5
62								3.7			2.3
64								3.5			2.1
66								3.3			2
68											2
70											2
72											1.9
ブーム 伸長率 (%)	I					0					46
	II					0					46
	III					0					0

\*アダプター

TAB 216429

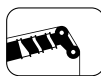

16.1m-  
50.1m

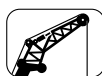

20°  
6m-  
63m

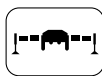

10m x 9.6m



360°



135t

メインブーム長さ		36.9m+2.2m*									42.1m+2.2m*
ジブ長さ		6m	14m	21m	28m	35m	42m	49m	56m	63m	6m
作業半径(m)											
9	76										
10	72										71
12	65										66
14	60	40.5									61
16	55	38									56
18	51	36.5	30								52
20	47.5	35	28.7	22.5							49.5
22	45	33.5	27.4	21.4							46.5
24	42	32	26.2	20.4	16.3						44
26	39.5	31	25.1	19.5	15.5						41.5
28	38	30	24	18.6	14.7	12.3					38
30	36	29.1	22.8	17.9	14.1	11.7					35
32	34.5	28.2	21.8	17.2	13.4	11.2					33
34	33	27.5	20.8	16.4	12.9	10.7					30.5
36	31	26.9	19.9	15.7	12.4	10.2					28.6
38	29.5	26.3	19	15	11.9	9.7					26.7
40	27.3	25.1	18.3	14.3	11.4	9.3			6.5		25.2
42		23.7	17.7	13.7	10.9	9			6.1		23.8
44		22.5	17.1	13.1	10.4	8.6			5.8		22.5
46		21.3	16.5	12.6	9.9	8.3			5.5		21.2
48		20.2	16	12.2	9.5	8			5.3		20
50			15.7	11.8	9.1	7.7			5		18.8
52			15.5	11.4	8.8	7.4			4.8		17.6
54			15.2	11	8.5	7.1			4.6		16.4
56			15	10.8	8.2	6.8			4.4		15.2
58				10.6	7.9	6.5			4.2		14
60				10.4	7.6	6.3			4		12.8
62				10.3	7.4	6			3.8		11.6
64					7.3	5.8			3.6		10.4
66					7.2	5.6			3.4		9.2
68					7	5.4			3.2		8
70					6.9	5.3			3		6.8
72						5.2			2.9		5.6
74						5.1			2.8		4.4
76						5.1			2.6		3.2
78									2.5		2
80									2.4		0.8
82									2.3		0
84									2.2		0
86									2.1		0
88									2		0
90									2		0
ブーム 伸長率 (%)	I					92					92
	II					92					92
	III					0					46

\*アダプター

TAB 216429

# チルトタイプ固定式ジブ定格総荷重表

TNZF

LTM 1550N



16.1m-  
50.1m



20°  
6m-  
63m

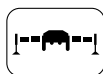

10m x 9.6m



360°



135t

メインブーム長さ ジブ長さ 作業半径(m)	47.3m+2.2m*										50m+2.2m*	
	6m	14m	21m	28m	35m	42m	49m	56m	63m	6m	63m	
12	65										54	
14	60										49.5	
16	55	38.5									45	
18	51	36.5									41.5	
20	47	35.5	28.3								38	
22	44	34	27.2								35.5	
24	40.5	33	26.1	20.1							33	
26	38	31.5	25.2	19.3							30.5	
28	35.5	30	24.3	18.6	14.5						28.2	
30	33	28.2	23.3	17.9	13.9						26.1	
32	30.5	26.6	22.4	17.3	13.4	11					24.1	
34	28.4	25.1	21.6	16.7	12.9	10.6					22.5	
36	26.6	23.6	20.7	16.1	12.4	10.1	7.9				21	
38	24.9	22.3	19.7	15.5	12	9.8	7.6				19.8	
40	23.3	21.1	18.7	14.9	11.6	9.4	7.2				18.5	
42	21.7	20	17.7	14.4	11.2	9	6.9	5.6			17.4	
44	20.5	19.1	16.8	13.9	10.8	8.7	6.6	5.4			16.3	4
46	19.4	18	15.9	13.4	10.4	8.4	6.4	5.2	4	3.9	15.2	3.8
48	18.4	16.9	15.2	12.9	10	8.2	6.1	4.8	3.7	3.7	14.3	3.6
50	17.4	15.9	14.5	12.5	9.6	7.9	5.9	4.6	3.5	3.5	13.3	3.4
52		15.1	13.8	12.1	9.3	7.7	5.7	4.4	3.3	3.2	12.5	3.3
54		14.3	13.2	11.7	9	7.5	5.5	4.2	3.2			3.2
56		13.6	12.5	11.2	8.7	7.2	5.4	4.1	3			3
58			11.9	10.7	8.4	6.9	5.2	3.9	2.9			2.9
60			11.3	10.2	8.2	6.6	5.1	3.8	2.8			2.7
62			10.7	9.7	7.9	6.4	4.9	3.7	2.6			2.6
64			10.1	9.3	7.7	6.2	4.7	3.5	2.5			2.5
66				8.9	7.5	6	4.5	3.4	2.3			2.3
68				8.4	7.3	5.9	4.3	3.3	2.2			2.2
70				7.9	7.1	5.7	4.2	3.1	2.1			1.9
72					6.8	5.5	4.1	3	1.9			1.7
74					6.5	5.4	3.9	2.8	1.8			
76					6.2	5.3	3.9	2.7	1.7			
78					5.9	5.2	3.7	2.6	1.6			
80						5.1	3.6	2.5				
82						4.9	3.5	2.4				
84						4.7	3.4	2.3				
86							3.4	2.2				
88							3.4	2.1				
90							3.3	2				
92							3.2	2				
94								2				
96								1.9				
98								1.9				
ブーム 伸長率 (%)	I				92							100
	II				92							100
	III				92							100

\*アダプター

TAB 216429



16.1m-  
50.1m



40°  
6m-  
56m

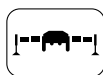

10m x 9.6m



360°



135t

メインブーム長さ ジブ長さ 作業半径(m)	16.1m+2.2m*									26.5m+2.2m*
	6m	14m	21m	28m	35m	42m	49m	56m	6m	
7	44.5									
8	42.5									
9	40.5									43
10	38.5									41.5
12	35.5									39
14	33									37
16	31	30.5								35
18	29.8	28.9								33.5
20		27.7								32
22		26.7	19							31
24		25.9	18							30
26		25.3	17.3	13.5						29.3
28			16.6	12.8						
30			16.1	12.2						
32			15.6	11.7	9.4					
34			15.4	11.2	8.9					
36				10.8	8.5					
38				10.5	8.1	6.6				
40				10.2	7.7	6.2				
42				10.1	7.4	5.9	4.7			
44					7.2	5.7	4.4			
46					7	5.4	4.2			
48					6.8	5.2	4			
50					6.8	5.1	3.8	3.1		
52						4.9	3.6	2.9		
54						4.8	3.4	2.8		
56						4.8	3.3	2.6		
58							3.2	2.5		
60							3.1	2.3		
62							3.1	2.2		
64								2.1		
66								2		
68								1.9		
ブーム 伸長率 (%)	I				0					46
	II				0					46
	III				0					0

\*アダプター

TAB 216430

# チルトタイプ固定式ジブ定格総荷重表

TNZF **LTM 1550N**



メインブーム長さ ジブ長さ 作業半径(m)	36.9m+2.2m*								42.1m+2.2m*
	6m	14m	21m	28m	35m	42m	49m	56m	6m
12	40.5								40.5
14	39								39
16	37								37.5
18	35.5	29.1							36
20	34.5	28.4							34.5
22	33	27.7	18.9						33.5
24	32	27.1	18.3						32.5
26	31.5	26.5	17.8						31.5
28	30.5	26.1	17.3	12.8					31
30	29.9	25.6	16.9	12.4					30.5
32	29.5	25.3	16.5	12					29.8
34	29.1	25.1	16.2	11.7	8.9				29.3
36		24.9	15.8	11.4	8.6				28.6
38		24.8	15.6	11.1	8.3				27.1
40		24.7	15.4	10.9	8.1	6.2			
42		23.9	15.2	10.6	7.8	6			
44			15.1	10.4	7.6	5.8			
46			15.1	10.3	7.5	5.6	4.2		
48			15.1	10.1	7.3	5.5	4.1		
50				10	7.1	5.4	3.9	2.9	
52				9.9	7	5.2	3.8	2.8	
54				9.9	6.9	5.1	3.7	2.6	
56				9.9	6.8	5	3.6	2.5	
58					6.7	4.9	3.5	2.4	
60					6.7	4.9	3.4	2.3	
62					6.7	4.8	3.3	2.2	
64						4.7	3.2	2.2	
66						4.7	3.2	2.1	
68						4.7	3.1	2	
70							3	1.9	
72							3	1.9	
74							3	1.8	
76								1.8	
78								1.8	
80								1.8	
82								1.8	
ブーム 伸長 (%)	I				92				92
	II				92				92
	III				0				46

\*アダプター

TAB 216430



メインブーム長さ ジブ長さ 作業半径(m)	47.3m+2.2m*								50m+2.2m*	
	6m	14m	21m	28m	35m	42m	49m	56m	6m	56m
14	39								39	
16	37.5								37.5	
18	36.5								36.5	
20	35	28.3							35.5	
22	34	27.7							34.5	
24	33	27.2	18.2						32.5	
26	32.5	26.6	17.7						30	
28	31.5	26.2	17.3						27.8	
30	31	25.8	17	12.3					25.8	
32	30.5	25.4	16.6	12					24.1	
34	28.6	24.3	16.3	11.7					22.6	
36	26.7	23	16	11.5	8.6				21.1	
38	25.1	21.9	15.8	11.2	8.3				19.8	
40	23.5	20.8	15.6	11	8.1				18.7	
42		19.8	15.4	10.8	7.9	6			17.6	
44		18.8	15.2	10.6	7.7	5.8			16.6	
46		18	15.1	10.4	7.5	5.7				
48			15	10.3	7.4	5.5	4			
50			14.4	10.1	7.3	5.4	3.9			
52			13.8	10	7.1	5.3	3.8			
54			13.3	10	7	5.2	3.7	2.6		2.6
56				9.9	6.9	5.1	3.6	2.5		2.5
58				9.9	6.8	5	3.5	2.4		2.4
60				9.9	6.8	4.9	3.4	2.3		2.3
62					6.7	4.8	3.4	2.3		2.3
64					6.7	4.8	3.3	2.2		2.2
66					6.6	4.8	3.2	2.1		2.1
68					6.6	4.7	3.2	2.1		2.1
70						4.7	3.1	2		2
72						4.7	3.1	2		2
74						4.7	3.1	1.9		1.9
76							3	1.8		1.8
78							3	1.8		1.8
80							3	1.8		1.7
82								1.8		1.5
84								1.7		
86								1.7		
88								1.7		
ブーム 伸長 (%)	I				92				100	
	II				92				100	
	III				92				100	

\*アダプター

TAB 216430

# チルトタイプ固定式ジブ定格総荷重表 (Y-ガイ仕様) TAY3NZF LTM 1550N

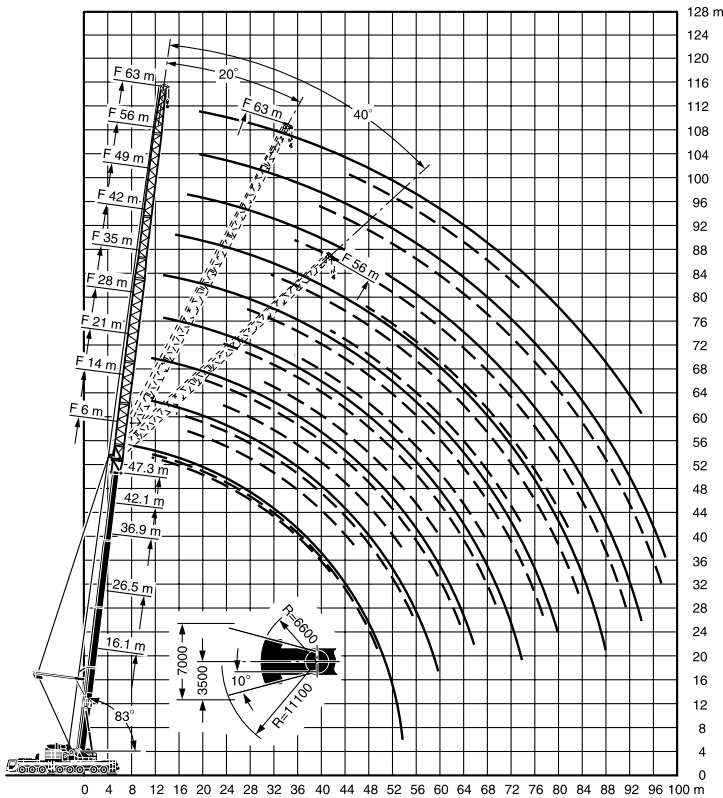

## 注意

- 1 定格総荷重はフックブロック、玉掛ワイヤー等の自重を含みます。  
また、下記の条件が考慮されていませんのでクレーンの操作には充分気をつけてください。  
① 地盤の強度、地震による影響  
② 作業速度に応じた動荷重および台風または強風による影響等
- 2 本機は水平に設置して、クレーン作業を行ってください。
- 3 作業半径は、クレーンの旋回中心から荷重の重心までの水平距離です。
- 4 メインブームの定格総荷重は補助ジブを取り除いた状態での値です。
- 5 メインブーム50m仕様で274トンを超える定格総荷重の場合は、特殊吊装置が必要です。

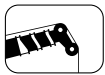

47.3m



0°  
6m-  
63m

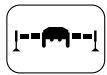

10m x 9.6m



360°



165t



メインブーム長さ ジブ長さ	47.3m+2.2m*									
	6m	14m	21m	28m	35m	42m	49m	56m	63m	
9	105									
10	104									
12	103	74								
14	97	68	56							
16	88	64	53	40						
18	80	60	49.5	37.5	32					
20	73	56	46.5	35	29.7	24.4				
22	67	53	44	33	27.9	22.9	18.4			
24	62	50	41.5	31.5	26.3	21.6	17.3	14.1	12	
26	57	47.5	39.5	29.7	24.9	20.4	16.3	13.3	11.2	
28	53	45	37.5	28.2	23.6	19.4	15.5	12.5	10.6	
30	48	43	36	26.8	22.4	18.4	14.7	11.9	10	
32	43.5	41	34	25.6	21.3	17.5	14	11.2	9.5	
34	39.5	39	32.5	24.5	20.3	16.7	13.3	10.7	9	
36	36.5	37.5	31	23.5	19.3	15.9	12.6	10.1	8.6	
38	33.5	35.5	29.8	22.5	18.5	15.2	12	9.6	8.1	
40	30.5	33	28.5	21.5	17.7	14.5	11.5	9.1	7.7	
42	28	31	27.3	20.6	17	13.9	10.9	8.7	7.3	
44	25.8	29.2	26.1	19.7	16.4	13.3	10.4	8.3	7	
46	23.8	26.9	25.1	18.8	15.7	12.8	10	7.9	6.6	
48	21.9	24.9	24.3	17.9	15	12.3	9.6	7.5	6.3	
50	20.2	23	23.2	17.2	14.3	11.8	9.2	7.2	6	
52	16.9	21.3	22	16.7	13.7	11.3	8.8	6.9	5.7	
54	9.5	19.7	20.5	16.1	13.1	10.8	8.5	6.6	5.4	
56		18.3	19	15.6	12.5	10.3	8.1	6.3	5.2	
58		16.9	17.6	15.1	12.1	9.9	7.7	6	4.9	
60		15.7	16.4	14.7	11.7	9.4	7.4	5.7	4.7	
62		12.4	15.2	14.2	11.3	9	7	5.5	4.5	
64			14.1	13.8	10.9	8.7	6.6	5.2	4.3	
66			13.1	13.3	10.5	8.4	6.3	4.9	4	
68			10.9	12.6	10.2	8.1	6	4.6	3.8	
70				11.7	9.8	7.8	5.8	4.4	3.6	
72				10.9	9.5	7.5	5.6	4.1	3.3	
74				9.3	9.1	7.2	5.3	4	3.2	
76				8.8	8.8	6.9	5.1	3.8	3	
78				8.6	8.7	6.7	4.9	3.6	2.8	
80				8.5	8.5	6.4	4.7	3.3	2.6	
82				7.9	7.9	6.2	4.6	3.2	2.5	
84				6	6	5.9	4.4	3	2.3	
86						5.8	4.2	2.9	2.1	
88						5	4	2.9	2	
90						3.4	3.9	2.7	1.9	
92							3.8	2.6	1.8	
94							3.7	2.5	1.6	
96							3.6	2.4	1.5	
98								2.2	1.3	
ブーム 伸長率 (%)	I				92					
	II				92					
	III				92					

\*アダプター

TAB 216564

# チルトタイプ固定式ジブ定格総荷重表 (Y-ガイ仕様) TAY3NZF LTM 1550N

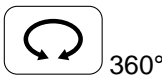

メインブーム長さ		47.3m+2.2m*								
ジブ長さ		6m	14m	21m	28m	35m	42m	49m	56m	63m
12	72									
14	67									
16	63									
18	59		39.5							
20	55		36.5	29.5						
22	52		35	28.3	21.6					
24	49		33.5	27.1	20.7					
26	46.5		32.5	26.1	19.9	15.7				
28	44.5		31.5	25.1	19.1	15.1				
30	42.5		30.5	24.2	18.4	14.4	11.9			
32	40.5		29.8	23.4	17.7	13.9	11.4			
34	38.5		29.1	22.7	17.1	13.3	10.9			
36	37		28.3	22	16.5	12.8	10.4	8.1		
38	34		27.7	21.4	16	12.4	10	7.7		
40	31		27	20.3	15.5	11.9	9.6	7.4	5.7	
42	28.5		26.4	20.3	15	11.5	9.3	7	5.4	
44	26.2		26.1	19.8	14.6	11.1	8.9	6.7	5.1	4.3
46	24.1		25.5	19.3	14.2	10.8	8.6	6.4	4.9	4.1
48	22.2		24	18.9	13.8	10.5	8.2	6.1	4.6	3.8
50	20.4		22.2	18.6	13.4	10.1	8	5.8	4.4	3.6
52			20.5	18.3	13	9.9	7.7	5.6	4.2	3.4
54			18.9	18	12.7	9.6	7.4	5.4	4	3.2
56			17.5	17.7	12.5	9.3	7.2	5.2	3.8	3.1
58				17.4	12.2	9	7	5	3.7	2.9
60				16.1	12.1	8.8	6.8	4.9	3.5	2.7
62				14.8	11.9	8.6	6.6	4.7	3.4	2.6
64				13.7	11.7	8.5	6.4	4.5	3.2	2.4
66					11.5	8.3	6.2	4.4	3.1	2.3
68					11.4	8.2	6	4.3	3	2.2
70					11.4	8	5.9	4.1	2.9	2.1
72						7.9	5.8	4	2.8	1.9
74						7.8	5.7	3.9	2.6	1.8
76						7.7	5.6	3.8	2.5	1.7
78						7.7	5.5	3.7	2.4	1.6
80							5.4	3.7	2.3	1.5
82							5.3	3.6	2.3	
84							5.3	3.5	2.2	
86								3.4	2.2	
88								3.4	2.1	
90								3.4	2	
92								3.4	2	
94									1.9	
96									1.9	
98									1.9	
ブーム伸長率 (%)	I					92				
	II					92				
	III					92				

\*アダプター

TAB 216566

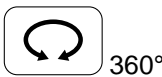

メインブーム長さ		47.3m+2.2m*						
ジブ長さ		6m	14m	21m	28m	35m	42m	49m
12	43							
14	41.5							
16	39.5							
18	38.5		29					
20	37		29.4					
22	36		27.7					
24	34.5		27.2	18				
26	34		26.7	17.5				
28	33		26.2	17				
30	32		25.7	16.6	11.9			
32	31.5		25.3	16.3	11.6			
34	30.5		25.1	15.9	11.2			
36	30		24.8	15.6	10.9	8.1		
38	29.8		24.5	15.3	10.7	7.9		
40	29.4		24.3	15.1	10.4	7.7		
42	28.8		24.1	14.9	10.2	7.4	5.7	
44			24	14.8	10	7.2	5.5	
46			24	14.6	9.9	7	5.4	
48				14.4	9.7	6.9	5.2	3.6
50				14.3	9.6	6.7	5.1	3.5
52				14.3	9.5	6.6	4.9	3.4
54					9.4	6.5	4.7	3.3
56					9.3	6.4	4.7	3.2
58					9.2	6.3	4.6	3.1
60					9.2	6.2	4.6	3
62						6.1	4.5	2.9
64						6.1	4.4	2.8
66						6.1	4.4	2.8
68						6.1	4.3	2.7
70							4.3	2.7
72							4.2	2.6
74							4.2	2.6
76								2.5
78								2.5
80								2.5
82								2.5
ブーム伸長率 (%)	I					92		
	II					92		
	III					92		

\*アダプター

TAB 216568

# チルトタイプ固定式ジブ定格総荷重表 (Y-ガイ+エキセントリック仕様) LTM 1550N

TEY3ENZF

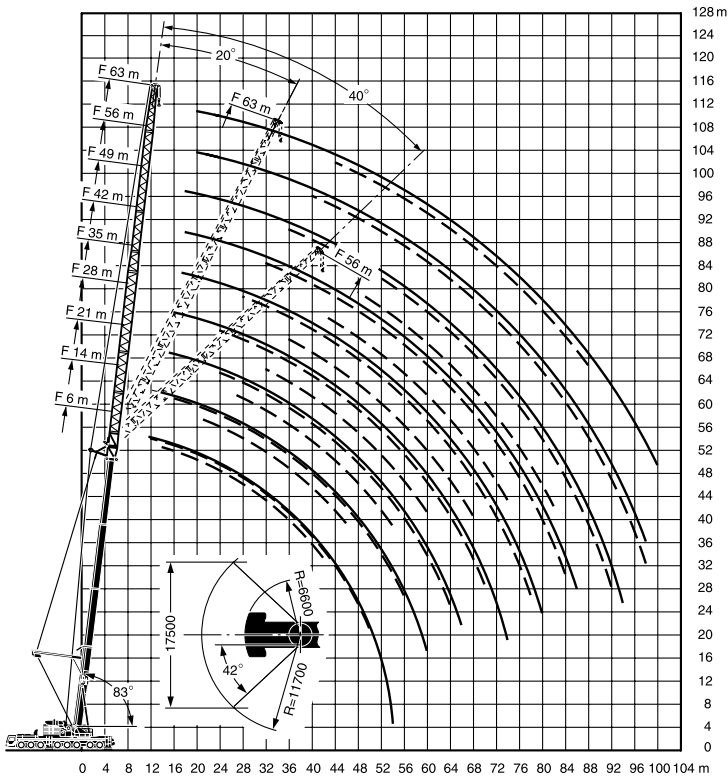

### 注意

- 1 定格総荷重はフックブロック、玉掛ワイヤー等の自重を含みます。  
また、下記の条件が考慮されていないのでクレーンの操作には充分気をつけてください。  
① 地盤の強度、地震による影響  
② 作業速度に応じた動荷重および台風または強風による影響等
- 2 本機は水平に設置して、クレーン作業を行ってください。
- 3 作業半径は、クレーンの旋回中心から荷重の重心までの水平距離です。
- 4 メインブームの定格総荷重は補助ジブを取り除いた状態の値です。
- 5 メインブーム50m仕様で274トンを超える定格総荷重の場合は、特殊吊装置が必要です。

47.3m
 6m-63m
 10m x 9.6m
 360°
 165t
 Y-ガイ

メインブーム長さ ジブ長さ	47.3m+2.2m*								
作業半径(m)	6m	14m	21m	28m	35m	42m	49m	56m	63m
10	114								
12	104								
14	92								
16	83								
18	75								
20	69								
22	63								
24	58								
26	49								
28	45.5								
30	42								
32	39								
34	35.5								
36	32.5								
38	29.9								
40	27.4								
42	25.2								
44	23.1								
46	21.3								
48	18.4								
50	14.7								
52	8								
54									
56									
58									
60									
62									
64									
66									
68									
70									
72									
74									
76									
78									
80									
82									
84									
86									
88									
90									
92									
94									
96									
98									
100									
ブーム 伸長率 (%)	I				92				
	II				92				
	III				92				

\*アダプター

TAB 216294

# チルトタイプ固定式ジブ定格総荷重表 (Y-ガイ+エキセントリック仕様) LTM 1550N

TEY3ENZF

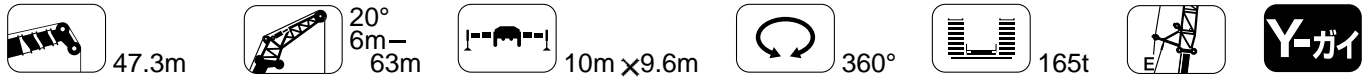

メインブーム長さ		47.3m+2.2m*								
ジブ長さ		6m	14m	21m	28m	35m	42m	49m	56m	63m
12	72									
14	67									
16	63									
18	59									
20	56		51							
22	53		49	31.5						
24	51		47	30						
26	48.5		44	29	22.1					
28	46.5		42.5	28	21.2					
30	44.5		41.5	27	20.4	16				
32	42.5		40	26.1	19.6	15.3				
34	39.5		39	25.3	18.9	14.7	12.3			
36	36.5		38.5	24.5	18.2	14.1	11.8			
38	33		37	23.7	17.7	13.6	11.3	9		
40	30.5		34.5	23.1	17.1	13.1	10.9	8.6		
42	27.9		32.5	22.6	16.6	12.7	10.5	8.2	6.4	
44	25.6		30	22.2	16.1	12.2	10.1	7.9	6.1	
46	23.5		27.6	21.4	15.6	11.9	9.7	7.5	5.8	4.5
48	21.6		25.5	21	15.2	11.4	9.4	7.2	5.5	4.3
50	19.1		23.5	20.6	14.8	11.1	9.1	6.9	5.3	4.1
52			21.7	20.2	14.4	10.8	8.7	6.7	5	3.9
54			20	19.8	14.1	10.5	8.4	6.4	4.8	3.7
56			18.4	19.6	13.8	10.2	8.2	6.2	4.6	3.6
58			16.9	18.3	13.5	9.9	7.9	6	4.4	3.4
60				16.9	13.2	9.7	7.7	5.7	4.3	3.2
62				15.6	13	9.5	7.4	5.5	4.1	3.1
64				14.4	12.8	9.2	7.2	5.3	4	2.9
66				13.2	12.6	9	7	5.2	3.8	2.8
68					12.5	8.9	6.8	5	3.7	2.7
70					12.2	8.7	6.6	4.8	3.5	2.5
72					11.2	8.6	6.5	4.7	3.4	2.4
74						8.4	6.3	4.6	3.3	2.3
76						8.4	6.2	4.4	3.2	2.2
78						8.3	6.1	4.3	3.1	2.1
80							5.9	4.2	3	2
82							5.9	4.2	2.9	1.9
84							5.8	4.1	2.8	1.8
86							5.7	4	2.7	1.7
88								3.9	2.6	1.6
90								3.9	2.6	1.5
92								3.9	2.5	1.4
94								3.9	2.4	1.4
96									2.4	1.3
98									2.4	1.3
ブーム伸長率(%)	I					92				
	II					92				
	III					92				

\*アダプター

TAB 216296

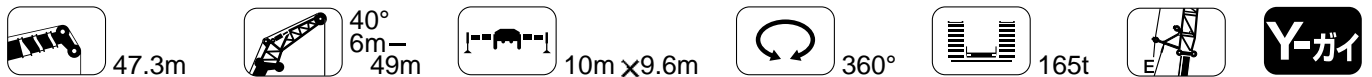

メインブーム長さ		47.3m+2.2m*						
ジブ長さ		6m	14m	21m	28m	35m	42m	49m
14	46.5							
16	45							
18	44							
20	42.5		37					
22	41.5		36.5					
24	40.5		36					
26	39.5		35	22				
28	38.5		34	21.5				
30	38		33.5	21				
32	37.5		33	20.7	14.4			
34	37		32.5	20.3	14.1			
36	36.5		32	20	13.8	10.6		
38	33.5		31.5	19.7	13.6	10.3		
40	31		31	19.4	13.3	10.1		
42	28.2		30.5	19.2	13.1	9.9	7.3	
44			28.4	19	12.9	9.7	7.1	
46			26.2	18.9	12.7	9.5	6.9	
48				18.8	12.5	9.3	6.8	5
50				18.7	12.4	9.1	6.6	4.9
52				18.7	12.2	8.9	6.5	4.7
54				18.7	12.2	8.8	6.3	4.6
56					12.1	8.7	6.2	4.5
58					12	8.6	6.1	4.4
60						8.5	6	4.3
62						8.4	5.9	4.2
64						8.4	5.8	4.1
66						8.3	5.7	4.1
68						8.3	5.6	4
70							5.6	3.9
72							5.5	3.9
74							5.5	3.8
76								3.8
78								3.8
80								3.8
82								3.8
ブーム伸長率(%)	I					92		
	II					92		
	III					92		

\*アダプター

TAB 216296

## リープヘル・ジャパン株式会社

なお、本仕様は予告なく変更することがあります。

〒230-0053 横浜市鶴見区大黒町5番39号

TEL 045-505-8687 (営業)  
045-505-8689 (サービス)  
FAX 045-505-8683

TD 221.01.DEFISR01.2007  
07.10.1000